

Operating instructions

for flow meters of the series: "VHM in Standard Version"



TABLE OF CONTENTS

	Page
1. Important information and legal notices.....	3
2. Functional description of the flow meter.....	4
3. General description	4
4. Flow Meter Selection	4
5. Declaration of Conformity	4
6. General requirements for operation	4
7. Maximum operating pressure	5
8. Information on EU Directive 2014/68/EU On pressure equipment	5
9. Flow measurement range	6
10. Installing the flow meter	6
11. Cleaning and rinsing the pipes before operating	7
12. Pre-amplifier	7
General information.....	7
The single pick-up.....	7
The dual pick-up.....	7
13. Application with directional detection	8
14. Output circuits for the various types of pre-amplifiers	9
15. Custom solutions	10
16. Maintenance, service life and warranty	10
17. Storage, return and disposal	10
18. Technical data for the VHM flow meter	11
19. Dimensions for VHM flow meter	11
20. Dimensions for AHM mounting plates.....	12
21. Type code for VHM, AHM.....	13
22. Technical data for VII*-*S**/N; VTI*-*S**/N single pick-ups	14
23. Electronic connection data for VII*-*S**/N; VTI*-*S**/N single pick-ups	15
24. Technical data for single pick-ups VEI*-*S**/N single pick-ups	16
25. Technical data for dual pick-ups VDI*-*S**/N dual pick-ups	16
26. Electronic connection data for VEI*-*S**/N single pick-ups; VDI*-*S**/N dual pick-ups ..	17
27. Type code signal pick-ups	18
28. Technical data for VHM-Titan	19
29. Dimensions for VHM-Titan	19
30. Type code for VHM-Titan	20
21. Technical data for single pick-ups VRI*-*S**/N; VWI*-*S**/N for VHM Titan	21
32. Electronic connection data for single pick-ups VRI*-*S**/N; VWI*-*S**/N for VHM Titan ..	21
33. Type code signal pick-ups for VHM Titan	22
34. Declaration of Non-Objection	23

The current publication of this operating instruction supersedes all information from previous publications. VSE reserves the right to make changes and substitutions. VSE is not liable for any printing errors. Reproduction, including excerpts, is permitted only after written approval by VSE. VSE reserves the right to modify technical data at any time. Last revised: 03/2025



1. IMPORTANT INFORMATION AND LEGAL NOTICES

Dear customer, dear user,

This operating instruction for flow meters of the “**VHM in Standard Version**” series by VSE Volutentechnik GmbH (VSE) contains information required to properly install and commission the flow meter for the intended purpose.

Any installation, commissioning, operation, maintenance and testing may only be carried out by trained and authorized personnel. The operating instructions must be read and followed carefully to ensure a trouble-free, proper and safe operation of the flow meter. In particular, the safety instructions are essential.

These operating instructions must be kept safe and accessible for the authorized personnel at all times. At no time should contents of the operating instructions be removed. A missing manual or missing pages must be replaced immediately if lost. The operating instructions can be requested at any time from VSE or downloaded from our website www.vse-flow.com. The operating instructions must be passed on to each subsequent user of the flow meter.

This operating instruction is not subject to any modification service by VSE. VSE reserves the right to make technical changes at any time without notice.

VSE makes no warranties, express or implied, with respect to commercial qualities and suitability for a particular purpose.

VSE accepts no liability for damage and malfunctions resulting from operating errors, failure to observe these operating instructions, improper installation, commissioning or maintenance as well as improper use of the flow meter.

The opening of the flow meter is absolutely not permitted. After an unauthorized opening or rebuilding as well as after a single, incorrect electrical connection of the flow meter, the warranty as well as the product liability by VSE will be void.

2. FUNCTIONAL DESCRIPTION OF THE FLOW METER

Flow meters from the VSE Volumentchnik GmbH measure the volumetric flow of fluids using the gear method. The two gears in the meter are put in motion by the fluid flowing through the flow meter. The motion of each tooth of the gear is measured by a single or dual signal pick-up that is securely mounted to the flow meter. When the gear rotates, each signal pick-up generates a digital output signal, when a tooth of the gear passes through the detection area. Each time a tooth passes, the single signal pick-up generates one signal, or in case of a dual pick-up, 2 or 4 electrical output pulses, depending on the jumper settings. The gap between the teeth and the housing encloses a volume of fluid, that is transported out, when the gear rotates. This volume of fluid displaced

by one gap/tooth mesh, is called the measurement volume V . This measurement volume V_m determines the value of the pulse depending on the size of the flow meter.

$$V_m (\text{l/Imp.}) = 1/\text{K-Factor}$$

The signal frequency of the output pulse is processed in the electronics receiving the signal and is proportional to the speed of gear rotation and the flow rate. The flow rate corresponds to the volume transferred, which is measured continuously by electronically counting the output pulses.

3. GENERAL DESCRIPTION

Please follow all instructions in this operating instructions; only this ensures trouble-free operation of the flow meters. VSE is not liable for any damage ensuing from not following of these instructions.

Opening the devices during the term of warranty is only authorised after consultation and approval of VSE.

4. FLOW METER SELECTION

The right choice (rating) of type and size of the flow meter is the deciding factor for the trouble-free and safe operation. Due to the wide variety of applications and flow meter versions, the technical data provided in the VSE catalogs are of a general nature. Certain properties

of the devices depend on type, size and measurement range, as well as on the fluid to be measured. Please contact VSE for exact type and size specifications.

5. DECLARATION OF CONFORMITY

"VHM" series flow meters are tested for their electromagnetic compatibility and noise emission according to the EMC regulations, and meet the requirements of the applicable, legally required EMC directives. They cannot be operated independently. They must be connected to a power source via cable, and they output digital signals for electronic processing. There is a declaration of conformity available for all flow meters.

Since the EM-compatibility of the overall measurement system also depends on the routing of cables, on proper connection of the shielding and on every device connected to the system. It must be ensured that all components meet the requirements in the EMC guidelines and that the electromagnetic compatibility of the entire system, machine or plant is assured.

All flow meters are tested according to the applicable, legally required EMC directives and are CE-certified.

6. GENERAL REQUIREMENTS FOR OPERATION

Before installation or operation, you must check the following properties of your system and take the following aspects and corresponding conditions in your system into account for trouble-free and safe operation of the system.

1. The medium to be processed

- Is the flow meter **suitable for the medium**?
- Is the medium **viscous** or **abrasive**?
- Is the medium **dirty** or is there **contamination** and **suspended particles in the medium**?
- What is the **size of the particles** of the solid material and could they **block the meter**?
- Are there any **fillers** or other **additives** in the medium?
- Is it necessary to install a **hydraulic filter** before the meter?
- Are the **pipelines clean** and free of scraps left over from the installation such as shavings or weld splatter?
- Is the **tank clean** and can **any foreign material** escape from of the tank and into the pipeline system?
- Is the type of medium changed often and is the system **thoroughly rinsed** after changing?
- Has all air been **completely bled** from the pipes and the overall system?
- Which **types of cleaners** are used?
- Can the **seals** withstand the cleaning agents and medium?
- Are the **seals suitable** for use with the medium to be measured (**compatible with the seals**)?

2. Hydraulic properties of the system

- Is the **maximum operating pressure of the system** lower than the maximum permissible operating pressure of the flow meter?
- Is the **maximum pressure drop Δp** (on the flow meter) below the maximum permissible pressure drop?
- Does an excessively great **pressure drop Δp** occur on the flow meter at maximum flow (e.g. with high viscosity)?
- Does the **flow range** of the flow meter (depending on viscosity) correspond to the provided flow?
- Note that the flow rate range is reduced at **high viscosities!**
- Does the temperature range of the flow meter correspond to the provided **maximum temperature** of the medium?
- Is the pipe **cross-section** large enough and are there any large pressure drops in the system?
- Are the **hydraulic connections** (supply and return) correctly connected and sealed?
- Does the **pump** have enough power to operate the system?
- A blocked flow meter can stop the flow throughout the system. Is an **overpressure valve / bypass** provided in the system?

3. Electronic processing and electrical safety

- Have you selected the best possible flow meter and is it equipped with the **proper preamplifier**?
- Does the **power supply voltage** of the flow meter correspond to the provided voltage?
- Is the supply voltage provided by the power supply or signal processor sufficiently **steady**?
- Does the power supply **output** the required amount of **power**?
- Was the electrical connection wired according to the **connection diagram** provided?
- Is the **cable shielding** connected to the ground conductor?
- Is there an equalizing conductor connecting the flow meter to the signal processor to eliminate any **voltage differences** between them?
- Is the flow meter securely connected to the **grounded PE conductor**?
- Is the measuring unit of the flow meter **isolated** from the grounded PE conductor (e.g. connected using a sleeve)?
If it is isolated, then the measuring unit must be connected to the grounded PE conductor!
- Is there a **continuous connection** from the cable shielding (grounded PE conductor) through the housing and the 4-pin round plug to the measuring unit of the flow meter?
- Is the cable routed to prevent interference and can any **stray pulses** be coupled?
- Is the **4-pin round plug** of the connecting cable screwed tightly to the connector on the flow meter?
- Are the wires on the **signal processor** correctly and properly connected?
- Does the overall system conform to the electromagnetic compatibility (**EMC**) directives as required by law?
- Are you following all locally applicable regulations, **applicable rules**, guidelines and basic requirements for **EMC**?
- Systems in which a malfunction or failure can lead to personal injury are to be equipped with **suitable safety equipment**.
The function of this safety equipment is to be checked at **regular** intervals.

7. MAXIMUM OPERATING PRESSURE

Before assembling the flow meter, you have to test that the max. **operating pressure** of the system does not exceed the max. permitted operating pressure of the flow meter. Meanwhile, observe the top pressures that can occur, when operating the system.

The following operating pressures are permitted depending on flow meter version:

- Flow meter "VHM" $p_{max} = 250 \text{ bar} / 3600 \text{ psi}$
- Flow meter "VHM Titan" $p_{max} = 10 \text{ bar} / 145 \text{ psi}$

8. INFORMATION ON EU DIRECTIVE 2014/68/EU ON PRESSURE EQUIPMENT

VSE flow meters are classified as „piping“ under Article 2, No. 3 of the aforementioned Directive and are therefore subject to this Directive. According to Article 4, paragraph (1c), VSE flow meters must comply with the technical requirements specified in Article 4 of the Directive. Only fluids of Group 2, according to Article 13, paragraph (1b) may be measured with the flow meters. If (hazardous) fluids of Group 1 are to be measured, VSE must be consulted.

The flow meters offered by VSE do not reach the limit values specified in Article 4, paragraph (1c) (ii). The technical requirements for VSE flow

meters are therefore limited to the criteria set out in Article 4, paragraph (3). This means that the devices must be designed and manufactured in accordance with good engineering practice in a Member State, which is hereby confirmed.

The paragraph also specifies that these units must not bear the CE marking referred to in Article 18. Therefore, a CE declaration of conformity is not issued in accordance with Directive 2014/68/EU.

The CE marking of our flow meters refers to Directive 2014/30/EU + Directive 2014/34/EU for our Ex-type flow meters.

9. FLOW MEASUREMENT RANGE

The flow measurement range ($Q_{\min} - Q_{\max}$) of the flow meter specified in the data sheet is based on a test medium consisting of hydraulic oil with a viscosity of $21 \text{ mm}^2/\text{s}$ at a temperature of 20°C . For the measurement range with viscosities $> 10 \text{ mm}^2/\text{s}$, VSE specifies a measuring accuracy

of up to 0.5% of the measured value and a repeat accuracy of 0.5%. For viscosities from 1 to $10 \text{ mm}^2/\text{s}$, a measuring accuracy of up to 1.0% of the measured value and a repeat accuracy of 0.5% is specified.

Important:

Make sure that the maximum permissible operating pressure specified for the flow meter cannot be exceeded in any operating mode of the system. Note the flow range of the flow meter, which depends on the viscosity of the medium to be measured.



10. INSTALLING THE FLOW METER

The flow meter should be installed in a location with easy access so that it can be easily removed to clean the gears. Since flow meters can operate in any mounting position and any direction of flow, you can mount them at any location you want in your system. When installing the flow meter you must make sure that there is always some fluid remaining in the flow meter and that it can never run dry, even when the system is not in operation. For this reason, the outlet of the flow meter should always be under a slight pressure since this firmly fixes the measuring unit of the flow meter in the fluid column (the measuring unit is supported in this fashion by the fluid column) and the pipeline cannot drain empty. In critical cases or when the pipe line is at standstill or standby and can run empty, it is strongly recommended to install an additional non-return valve in the outlet line.

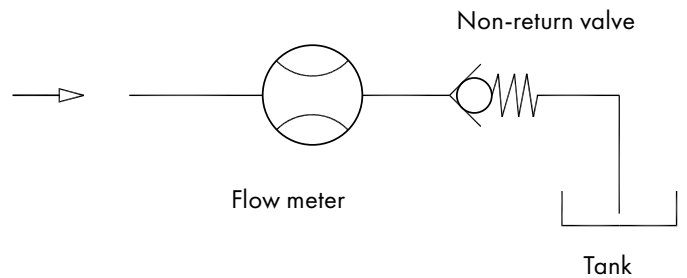

Fig. 1: Flow meter installation with non-return valve

Important:

Make sure that both the inlet and outlet of the measuring unit of the flow meter is always completely full and that there is some pressure on the outlet. This prevents the creation of gas bubbles and the destruction of the measuring unit, by a sudden and steep increase of flow and at the same time improves measurement accuracy.



Series "VHM" flow meters can be mounted with screws on a mounting plate installed in the pipe. Whenever possible, you should choose large diameter pipes for the piping system and large diameter lines for the hydraulic supply and return. This reduces the effect of a pressure drop and lowers the flow rate in the overall system.

VSE supplies subplates with various pipe thread sizes and with mounting holes on the side or back for all flow meters in the "VHM" series. Depending on the present conditions, the installed pipe, the pipe diameter or the type of pipe thread, the user can choose the appropriate subplate and install it in the system or machine without requiring any reduction fittings.

The flow meter is screwed onto the subplate using pan head screws. Tighten the screws by hand as tight as they will go first. In special cases, the flow meter can also be mounted directly in the pipe.

Important:

When mounting the flow meter, you must make absolutely sure that the seals are not damaged in any way and are seated correctly in the hydraulic connections of the flow meter. Incorrectly installed or damaged seals can result in leakage and a leaky system, which can have significant consequences in certain cases.

The yellow plastic stoppers in the hydraulic connections of the flow meter protect the measuring unit from dirt and contamination, when the flow meter is placed in storage or for transportation purposes. You must remove these stoppers so that the inlet and outlet are unplugged and open before you mount the flow meter.



11. CLEANING AND RINSING THE PIPES BEFORE OPERATION

Before you operate the flow meter, you must carefully clean and rinse the entire system so that no foreign particles can get into the measuring unit of the flow meter, when it is being installed. Foreign particles can block the measuring unit and damage it so badly that the flow meter is unable to supply any valid measurement values any more and must be sent in for repair. After completion of the system or installation of the piping, you must carefully clean and rinse the entire piping system and the tank first. The flow meter must be removed from the piping system. Use a rinsing agent that is compatible with the medium to be used later during operation and will not cause any undesired reactions. You can obtain the corresponding information from your supplier, the manufacturer of the medium or from VSE.

Flow meters are measuring sensors manufactured to high precision. They have a mechanical measuring unit consisting of two gears fit tightly with small gaps between them and the housing. Even the least damage to the gears or bearings will cause a measurement error. For this reason, you must always make sure that no foreign particles can get into the measuring unit and that the medium being measured is always completely free from contamination. Once the system has been thoroughly rinsed and there are no foreign particles in the piping system, you can mount the flow meter and start operations.

Important:

Please clean the pipes and the tank thoroughly since foreign particles and residue can get into the measuring unit and block it or even destroy it.



12. PREAMPLIFIER

General information

The preamplifiers are supplied in different versions depending on the type of application. Single and dual pick-ups are available. The basic method used to sense and measure, though, is the same for both ver-

sions and is based on the carrier frequency principle. When a dual pick-up is used, you simply double or quadruple the number of pulses received depending on the setting.

The single pick-up

The single pick-up operates with a carrier frequency oscillator that is modulated whenever a tooth passes by. This modulation is evaluated by the subsequent preamplifier electronics and generates a modula-

ted digital pulse proportional to the volume delivered. The number of pulses is proportional to the volume delivered. The flow rate can be derived from the frequency of this pulse signal.

The dual pick-up

The dual pick-up operates with two independent carrier frequency oscillators that are modulated whenever a tooth passes by. The electronics generates a pulse signal for each modulation. The pulses from both pick-up systems are combined in the subsequent preamplifier electronics and output as a double pulse. If necessary, you can select

pulse quadrupling by changing the internal code (resetting a jumper), although the max. flow range is thereby reduced. The volume of fluid transported and the flow rate can be derived from the number of pulses and the frequency.

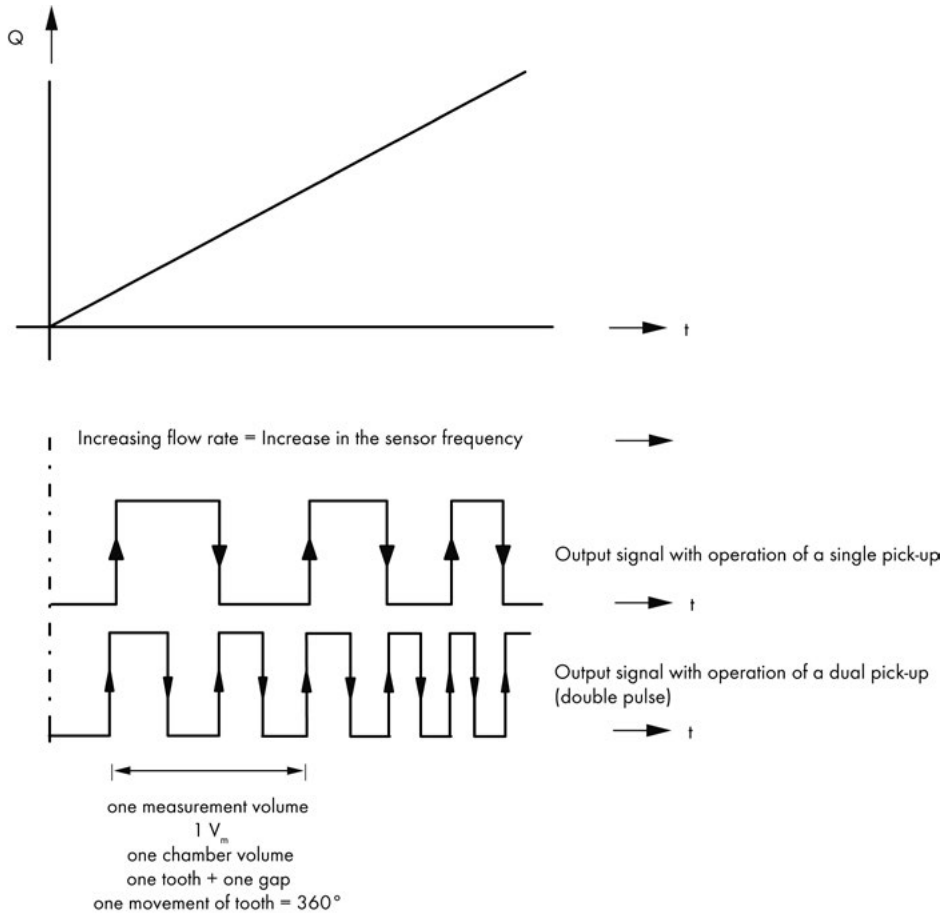

Figure 2: Signal output of the preamplifier

13. APPLICATION WITH DIRECTIONAL DETECTION

If it is necessary to detect the flow direction, then the flow meters are operated by two single pick-ups type VII^{*}-S^{**}/N and VTI^{*}-S^{**}/N. The two single pick-ups are set up with a mechanical phase offset of 90° with respect to the tooth flank sequence.

To prevent the signals of two single pick-ups from interfering with each other, you should select pick-ups with two different carrier frequencies,

i.e. one with a normal carrier frequency (VII^{*}-S^{**}/N) and one with a modified carrier frequency (VTI^{*}-S^{**}/N).

The 90° phase offset between the two pulse signals allows you to increase the resolution by processing the rising and falling edges from both channels. Processing the signals in this manner allows for a resolution of $1/4$ of the measured volume.

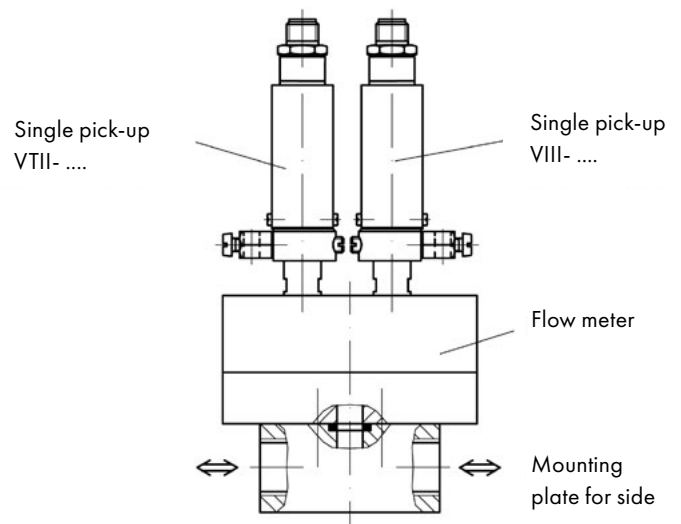

Figure 3: Application with directional detection

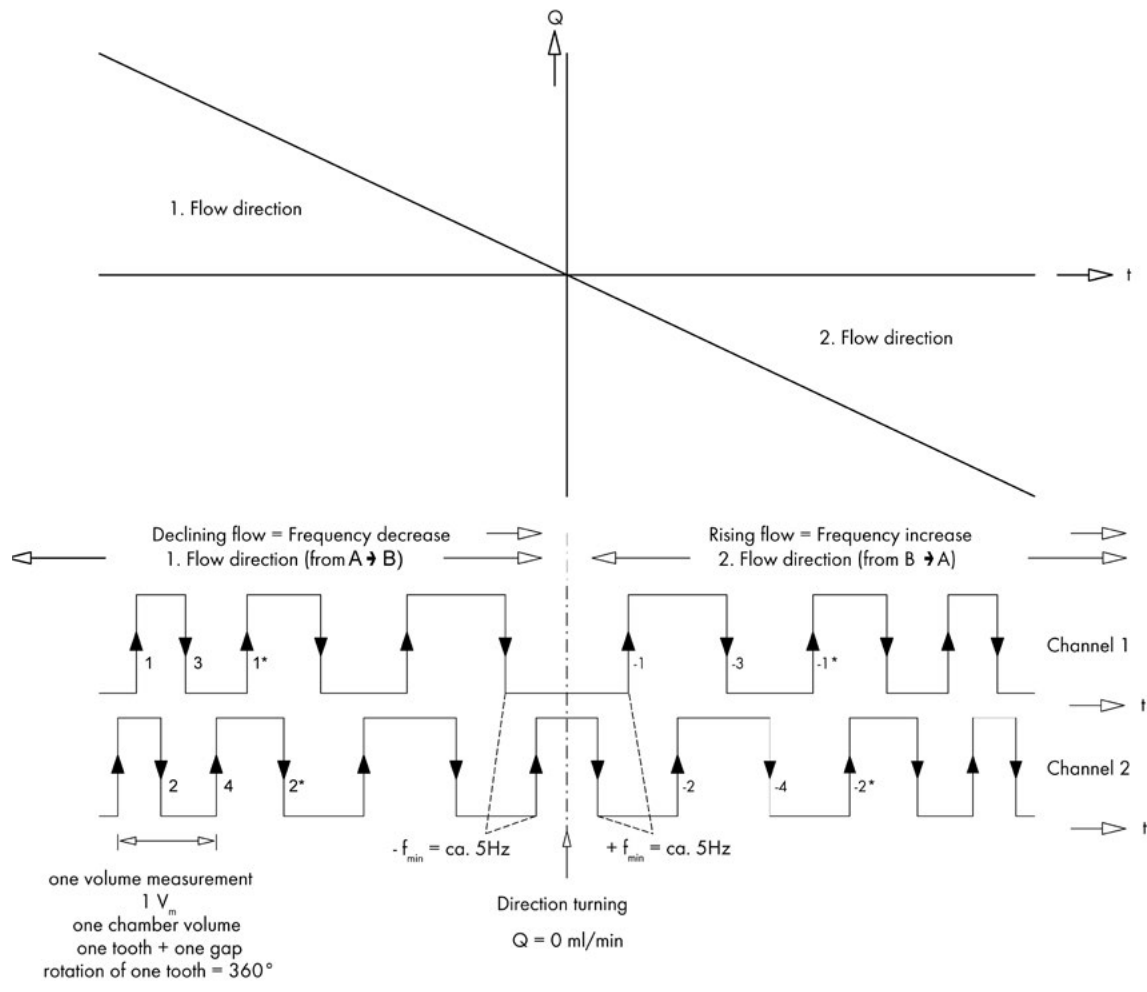

Figure 4: Signal output with two single pick-ups

14. OUTPUT CIRCUITS FOR THE VARIOUS TYPES OF PREAMPLIFIERS

There are two versions of single pick-ups available. Single pick-up VII*-S**/N (VTI*-S**/N, with modified frequency) and single pick-up VEI*-S**/N in the round-face housing of the dual pick-up. The single pick-up VII*-S**/N (VTI*-S**/N) is placed in a small tube housing so that it can also be used as a sensing system for other applications like turbines, for example. The VII*-S**/N and VTI*-S**/N have two transistor outputs for a PNP or NPN output signal (see the wiring diagrams). The preamplifier electronic for operating especially lightweight titanium flow meter is identical to the VII*-S**/N (VTI*-S**/N) preamplifier electronic and is labeled with VRI*-S**/N and VWI*-S**/N.

The single pick-up VEI*-S**/N and the dual pick-up VDI*-S**/N in the round-faced housing have an optocoupler transistor in the output for an electrical isolation from the operating voltage of the pick-up. The transistor output can be supplied with voltage using the operating voltage of the flow meter or using a separate power supply. A PNP or NPN output signal is generated depending on the polarity of the power supply voltage on the transistor (see wiring diagrams).

The power supply voltage range is $U_b = 8 \dots 30$ V DC. You can operate the preamplifier with any voltage in this specified voltage range (U_b), but make sure that the signal voltage is always adjusted to the power supply voltage. A steady direct voltage with a maximum residual ripple of $\pm 10\%$ is permitted for the power supply. In all standard versions of the "VHM" series are 2 additional 620 Ω resistors connected in series, in order to limit the current at the transistor output.

Important:
Please make sure that no extra inductive elements are connected in the power supply of the flow meter, such as contactors, relays, valves, etc. These components are potential sources of interference. They generate high interference pulses, when switched and can interfere with the functioning of the flow meter, although this complies with the electromagnetic compatibility directives (especially if the inductive elements are not provided with an adequate protective circuit).



The maximum current per channel is $I_{k_{max}} = 10$ mA for an operating voltage > 16 V DC (the current I_k depends on the input impedance of the signal processor).

The electric connection of the flow meter is performed via the 4-pin round plug located on the preamplifier housing. The connection cable plug is plugged into the plug connection of the flow meter and screwed together.

Important:

Only use well-shielded cables for the connection cable, with a wire cross section of $\geq 4 \times 0.36$ mm². Please make sure that the housing of the round plug is metallic, containing a connection for the shielding and that the potential of the earth conductor PE is connected to the cable shielding and the housing of the preamplifier.



The shielding of the connection cable is connected to the union nut of the plug and is thereby connected to the preamplifier housing and the flow meter. For proper EMC operation of the sensor system, at least one side must be connected to the grounded PE conductor. This connection is usually established by the grounded pipe on the side of the flow meter. You must take care of voltage differences and install potential equali-

sation, if necessary. A corresponding connection is presenting on every type of preamplifier. The shielding of the cable must be routed continuously up to the flow meter, and may not be interrupted in distribution racks or junction boxes. Route the connection cable directly from the signal processor to the flow meter if possible, as every interruption in the connection is a potential source of error.

Important:

Voltage differences can arise between the housing of the preamplifier and the earth conductor PE of the signal processor. In this case a potential equalisation ground must be installed (see the wiring diagram)!



The maximum length of the cable between the flow meter and the signal processor is approx. 120 m. When long cables are used

(approx. 40 m and longer), you must make absolutely sure that the connection cable is routed through an interference free environment.

15. CUSTOM SOLUTIONS

There are some applications in which you will need a lightweight pick-up, for example. This is often the case in the field of automation. VSE offers custom solutions made of titanium that are especially lightweight. If your application has other requirements, please contact VSE in this regard.

VSE has years of experience and can provide solutions quickly to meet special requirements by modifying the mechanical and/or electrical components of existing solutions.

16. MAINTENANCE, SERVICE LIFE AND WARRANTY

Depending on the operating conditions, the service life and specific properties of the flow meter are limited by wear, corrosion, deposits, or ageing. The operator is responsible for regular inspection, maintenance, and recalibration. In case of detected malfunctions or damage, operation must be immediately stopped. On request, we can provide a

replacement flow meter for the duration of the repair. We recommend an annual inspection and recalibration. Under normal operating conditions, the service life is approximately 10,000 hours. The warranty period is 12 months.

17. STORAGE, RETURN AND DISPOSAL

Temporary storage

All VSE flow meters are delivered with sealing plugs and in suitable packaging for all destinations and transport types, ensuring optimal protection. The flow meters should always be stored in their original foam packaging or transport boxes. The flow meters must not be exposed to temperatures below -20°C or above $+40^{\circ}\text{C}$ and must be protected from direct sunlight and moisture or its effects. The maximum storage period is 48 months. If the maximum storage time is exceeded, the flow meter must be disassembled by the manufacturer VSE or an authorised service partner. This includes cleaning, replacing the seals, and recalibration.

Return

1. The flow meter must be properly cleaned before being returned to prevent the risk of poisoning/contamination of humans and the environment from harmful, explosive, or otherwise hazardous media.
2. If media have been measured whose residues can cause corrosion or ignite on contact with oxygen, the flow meter must be additionally neutralised and thoroughly dried with anhydrous, inert gas.
3. The return of the flow meter must always include a fully completed declaration of non-objection (see page 23). All applied safety and decontamination measures must be specified.
4. When returning the flow meter, it must be packed according to applicable logistics standards and sealed with sealing plugs.

Disposal

VSE actively promotes environmental protection and is certified according to ISO 9001:2015 (Environmental Management). The environmental and human impact should be minimised during production, storage, transport, use and disposal of our products and solutions:

- Collect rinsing liquid as well as residual fluids and dispose them according to statutory provisions and regulations.
- Wear protective clothing and a protective mask/goggle if necessary.

Materials must be properly disposed of as follows:

- Metal
- Plastics
- Electronic components
- etc.

Disposal must comply with the waste-related regulations and requirements of the respective destination country!

18. TECHNICAL DATA FOR THE VHM FLOW METER

Size	Measurement range l/min	Measured Volume V_m ml	Frequency Hz	K-Factor imp./liter
VHM 01-1	0.01 ... 1	approx. 0.035	approx. 5.0 ... 476.0	approx. 30,000
VHM 02-1	0.05 ... 2	approx. 0.120	approx. 6.9 ... 278.0	approx. 8,800
VHM 02-2	0.10 ... 4	approx. 0.225	approx. 7.4 ... 296.0	approx. 4,400
VHM 02-3	0.40 ... 8	approx. 0.450	approx. 14.8 ... 296.0	approx. 2,200
VHM 03-2	0.50 ... 20	approx. 1.010	approx. 8.25 ... 330.0	approx. 1,000

The exact data can be found in the calibration report.

Measurement accuracy	± 0.5 % of the measured value (at viscosities > 10 mm ² /s) ± 1 % of the measured value (at viscosities 1 – 10 mm ² /s)
Repeating accuracy	± 0.5 % under the same operating conditions
Materials	Gear housing: Stainless steel 1.4404 Gears: Stainless steel 1.4462 Gear bearings: tungsten carbide Preamplifier housing: Stainless steel 1.4305 or aluminum
Gear bearings	Sleeve bushing, ball bearings (optional)
Seals	PTFE with FPM core (standard) or PTFE
Max. operating pressure	250 bar / 3600 psi
Media temperature	-20°C ... + 120°C (-4°F ... 248°F) (*)
Ambient temperature	-20°C ... + 60°C (-4°F ... 140°F) (*)
Viscosity range	1 ... 20,000 mm ² /s
Installation position	Any
Direction of flow	See direction of the arrow on the flow meter
Installation	On the mounting plate with piping connections or as a piping system (custom version)

(*) Note the temperature range of the preamplifier as well in this case.

19. DIMENSIONS FOR VHM FLOW METER

VHM 01/02

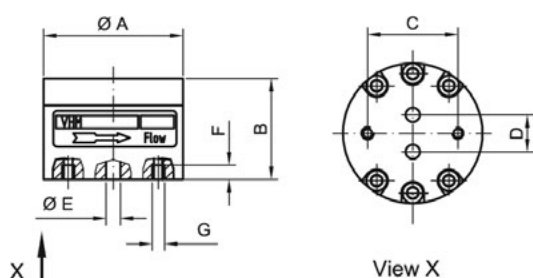

VHM 03

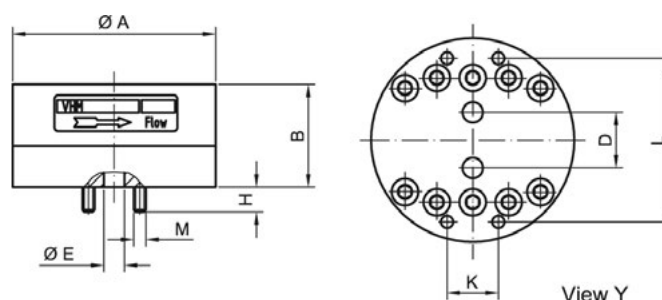

Type	øA	B	C	D	øE	F	G	K	L	M	H	Weight kg
VHM 01-1	68	29	44	12	4	6	M6					0.760
VHM 02-1	68	29	44	18	6	6	M6					0.740
VHM 02-2	68	34	44	18	6	6	M6					0.860
VHM 02-3	68	43	44	18	6	6	M6					1.075
VHM 03-2	99	50		27	10			25	81	M6	12	2.700

Dimensions are specified in mm

20. DIMENSIONS FOR AHM MOUNTING PLATES

AHM 01/02 for side-mounting

AHM 03 for side-mounting

Position of cable connections

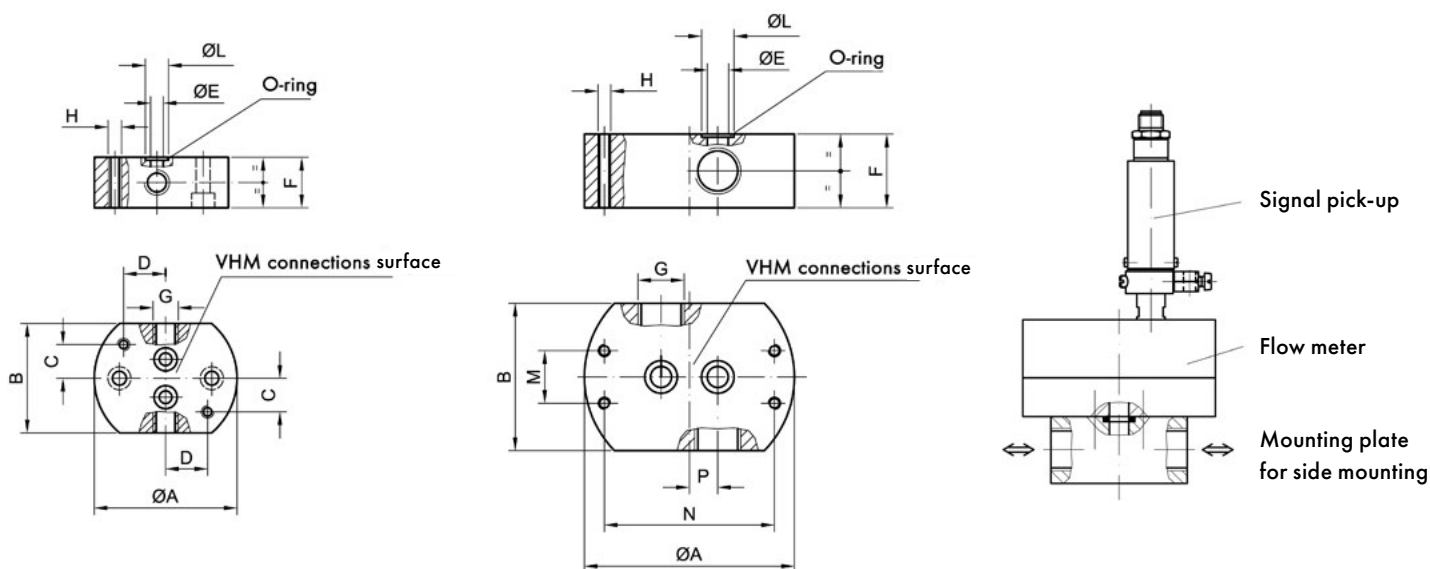

Permissible Size VHM	G	A	B	C	D	øE	F	H	øL	M	N	P	O-ring
01 - 1	G 1/8"	68	52	16	20	4	24	M6	9.4				6.07 x 1.78
	G 1/4"												
01 - 2 02 -1,2,3	G 1/8"	68	52	16	20	6	24	M6	11				7.65 x 1.78
	G 1/4"												
	1/8" NPT												
	1/4" NPT												
	G 3/8"												
3/8" NPT	68	52	16	20	6	35	M6	11					
03	G 3/8"	100	70			10	35	M6	15.5	25	81	13.5	12.42 x 1.78
	G 1/2"												
	3/8" NPT												
	1/2" NPT												

Dimensions are specified in mm

21. TYPE CODE FOR VHM, AHM

VHM flow meter

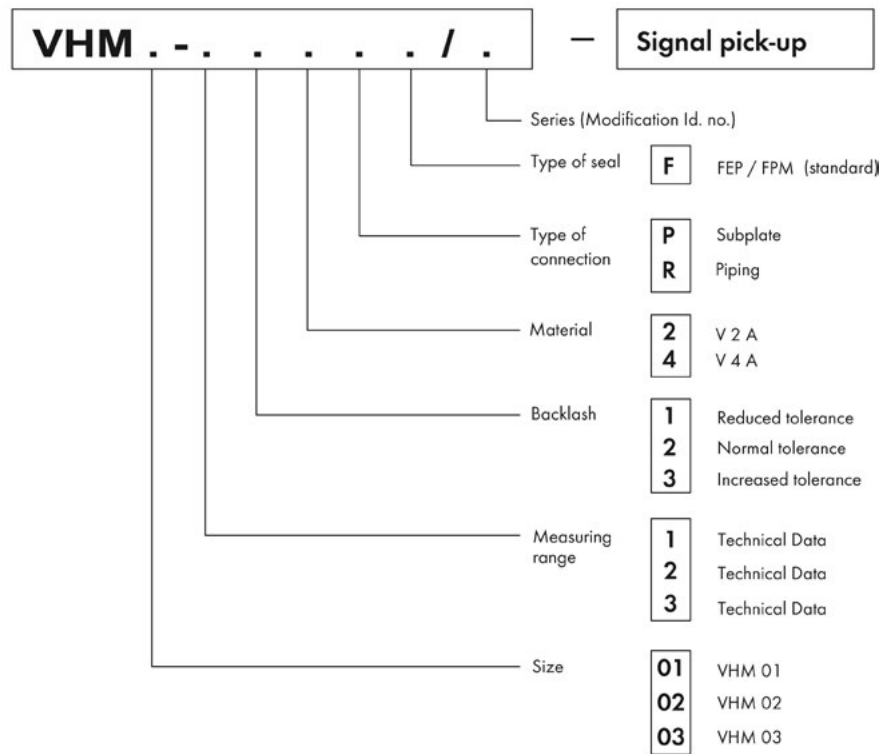

AHM mounting plate

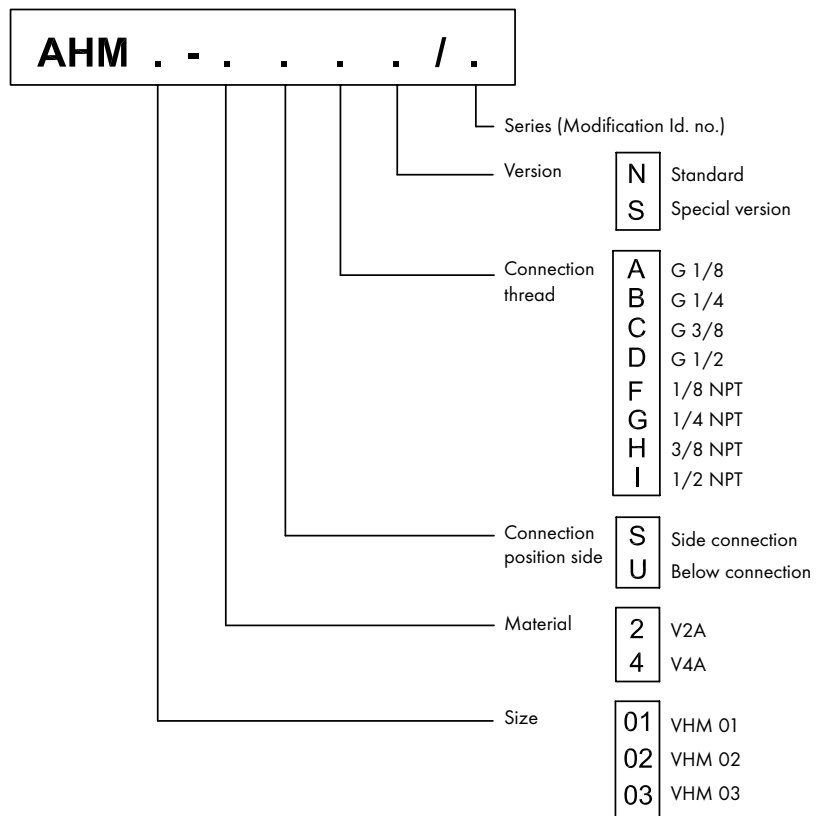

22. TECHNICAL DATA FOR VII^{*}-*S^{**}/N, VTI^{*}-*S^{**}/N SINGLE PICK-UPS

Supply voltage	$U_b = 8 \dots 30 \text{ V DC } \pm 10\%$
Current consumption (idle)	$I_b = \text{ca. } 4 \text{ mA (bei } 30 \text{ V DC)}$
Signal output circuit	Transistor with series resistor $R = 2 \times 620 \ \Omega$ PNP and NPN selectable
PNP signal output	High Signal: $U_s = U_b - 1 \text{ V}$; $I_s = 10 \text{ mA max.}$
NPN signal output	Low Signal: $U_s = 0 \text{ V}$; $I_s = 10 \text{ mA max.}$
Signal switching frequency	3 Hz – approx. 1000 Hz (*)
Electrical connection	4-pole VSE standard plug M 12
Medium temperature	$-20^\circ\text{C} \dots +120^\circ\text{C}$ ($-4^\circ\text{F} \dots 248^\circ\text{F}$)
Ambient temperature	$-20^\circ\text{C} \dots +60^\circ\text{C}$ ($-4^\circ\text{F} \dots 140^\circ\text{F}$)
Material	Stainless steel 1.4305
Weight	115 g

(*) Depends on the VHM flow meter size

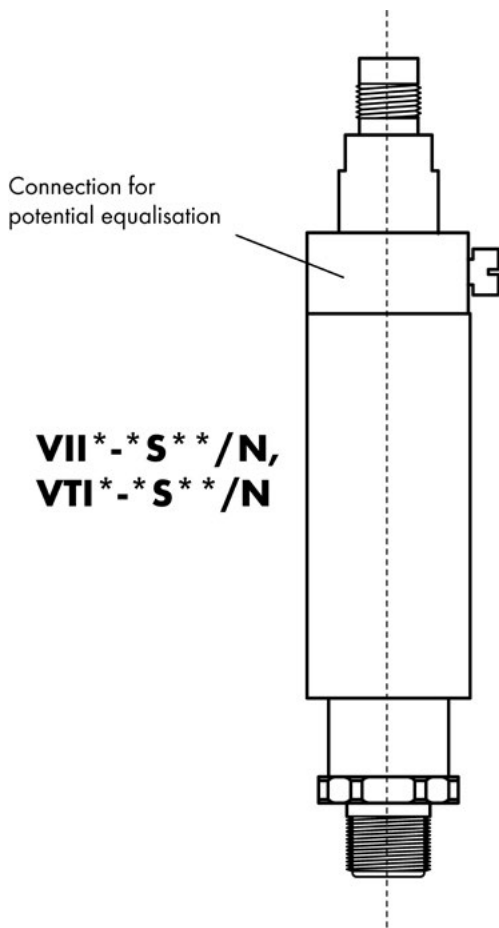
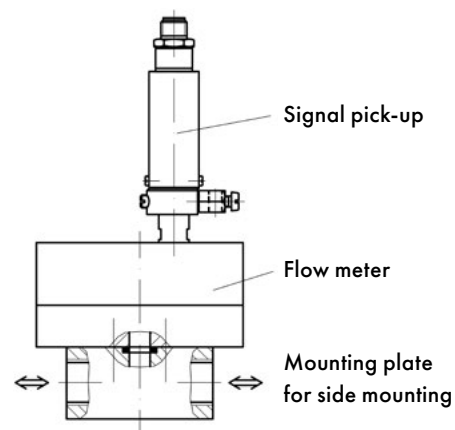

Dimensions

$\varnothing = 25 \text{ mm}$; length = 119 mm

Pin No. 2
(line color white)
Signal output PNP

Pin No. 3
(line color blue)
Power supply 0V

Pin No. 1
(line color brown)
Power supply U

Pin No. 4
(line color black)
Signal output NPN



Pin configuration

23. ELECTRONIC CONNECTION DATA FOR VII^{*}-*S^{**}*/N, VTI^{*}-*S^{**}*/N SINGLE PICK-UPS

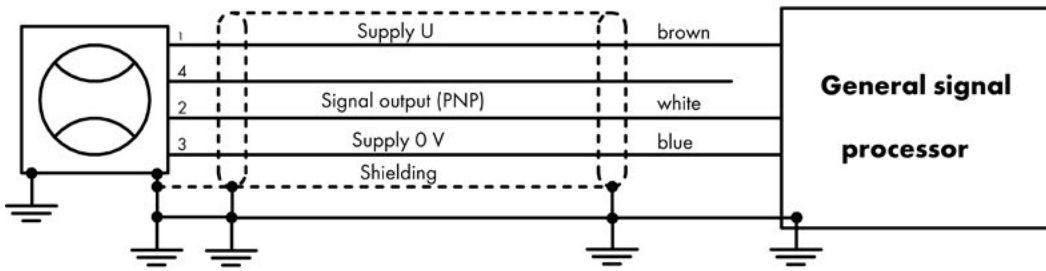
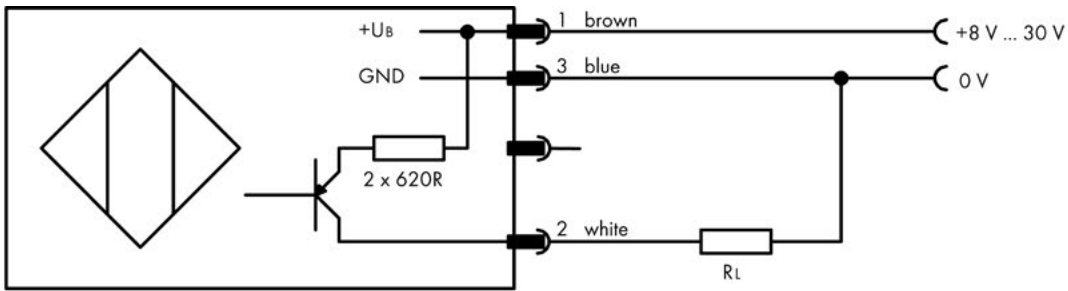

Output signal PNP-switching

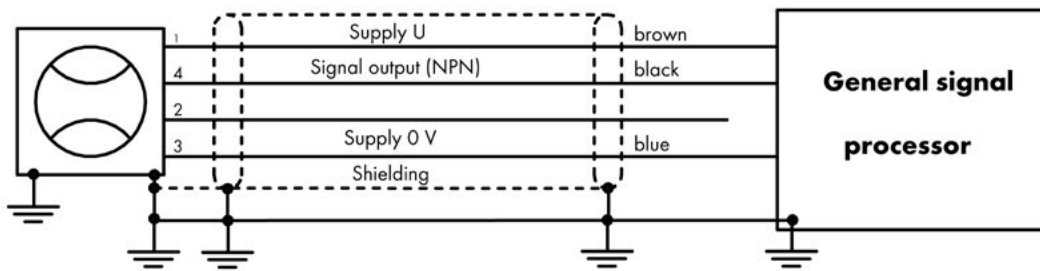
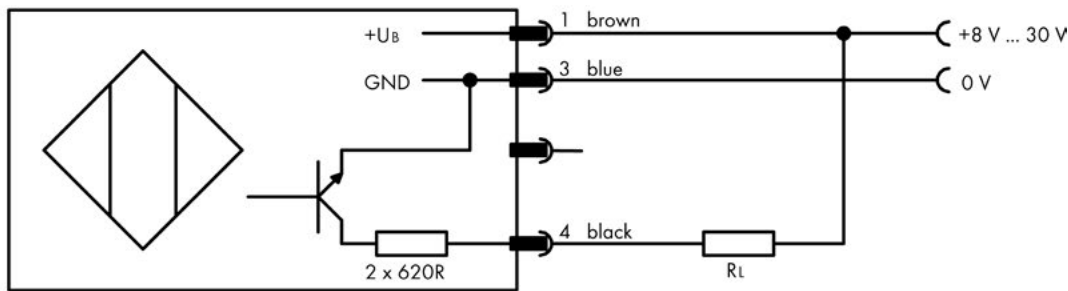

Signal output NPN-switching

24. TECHNICAL DATA FOR VEI*-*S**/N SINGLE PICK-UPS

Supply voltage	$U_b = 8 \dots 30 \text{ V DC } \pm 10\%$
Current consumption (idle)	$I_b = \text{approx. } 2.5 \text{ mA}$ (idle motion, $U_b = 30 \text{ V DC}$)
Signal output circuit	Transistor with series resistor $R = 2 \times 620 \Omega$ PNP and NPN selectable by external connection
PNP signal output	High Signal: $U_s = U_b - 1 \text{ V}$; $I_s = 10 \text{ mA max.}$
NPN signal output	Low Signal: $U_s = 0 \text{ V}$; $I_s = 10 \text{ mA max.}$
Signal switching frequency	3 Hz – approx. 500 Hz
Electrical connection	4-pole VSE standard plug M 12
Medium temperature	$-20^\circ\text{C} \dots +85^\circ\text{C}$ ($-4^\circ\text{F} \dots 185^\circ\text{F}$)
Ambient temperature	$-20^\circ\text{C} \dots +60^\circ\text{C}$ ($-4^\circ\text{F} \dots 140^\circ\text{F}$)
Material	Anodized black aluminum stainless steel 1.4305 (coil)
Weight	165 g

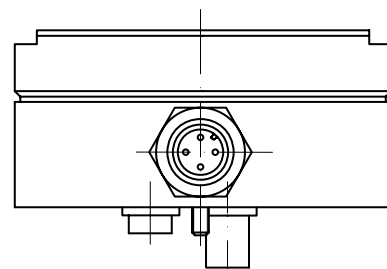

25. TECHNICAL DATA FOR VDI*-*S**/N DUAL PICK-UPS

Power supply voltage	$U_b = 8 \dots 30 \text{ V DC } \pm 10\%$
Current consumption (idle)	$I_b = \text{approx. } 4 \text{ mA}$ (bei 30 V DC)
Signal output circuit	Transistor with series resistor $R = 2 \times 620 \Omega$ PNP and NPN selectable by external connection
PNP signal output	High Signal: $U_s = U_b - 1 \text{ V}$; $I_s = 10 \text{ mA max.}$
NPN signal output	Low Signal: $U_s = 0 \text{ V}$; $I_s = 10 \text{ mA max.}$
Signal switching frequency	6 Hz – 500 Hz (pulse doubling) (*) 12 Hz – 500 Hz (pulse quadrupling) (*)
Electrical connection	4-pole VSE standard plug M 12
Media temperature	$-20^\circ\text{C} \dots +85^\circ\text{C}$ ($-4^\circ\text{F} \dots 185^\circ\text{F}$)
Ambient temperature	$-20^\circ\text{C} \dots +60^\circ\text{C}$ ($-4^\circ\text{F} \dots 140^\circ\text{F}$)
Material	Anodized black aluminum Stainless steel 1.4305 (coil)
Weight	165 g

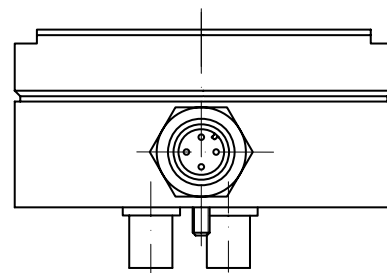

(*) Note that the flow measurement range is limited due to the quadrupling pulse mode

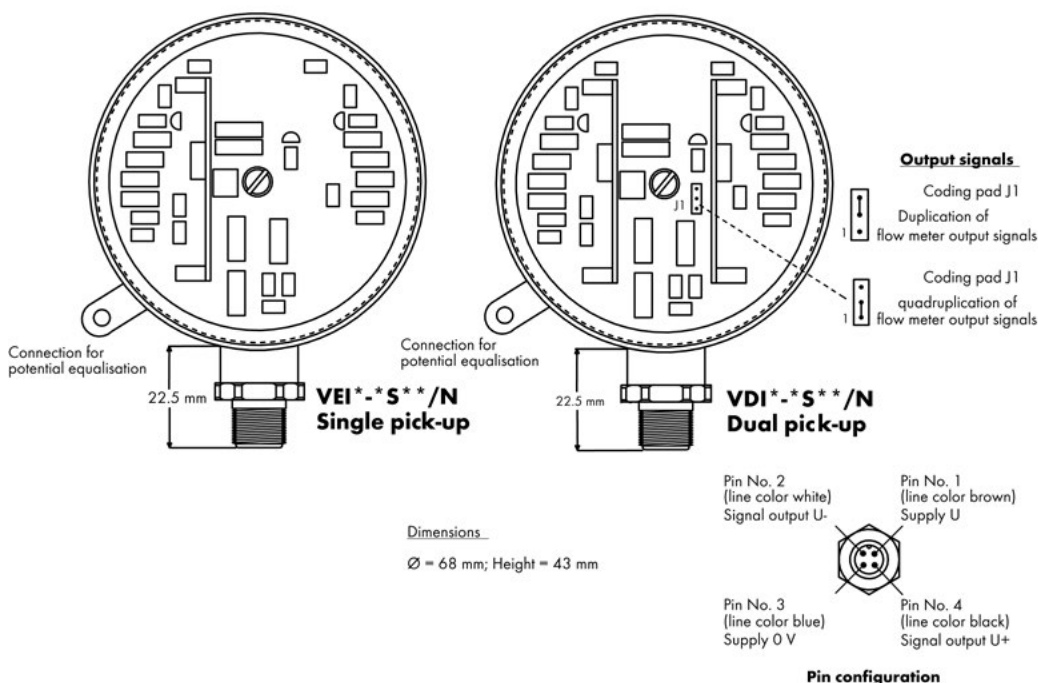

26. ELECTRONIC CONNECTION DATA FOR VEI*-S/N SINGLE PICK-UPS,
VDI*-S**/N DUAL PICK-UPS**

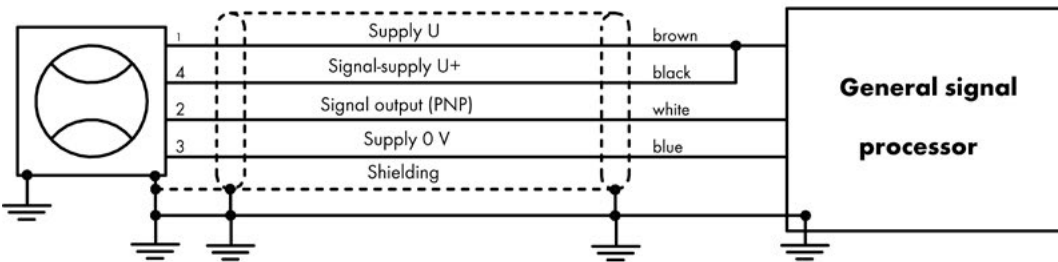
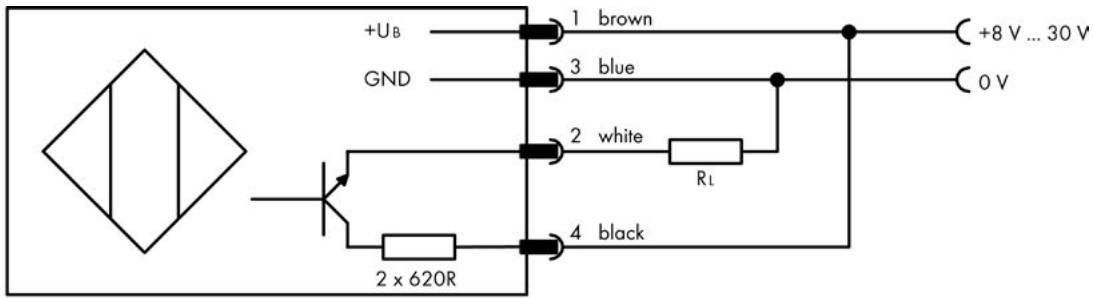

Signal output PNP-switching

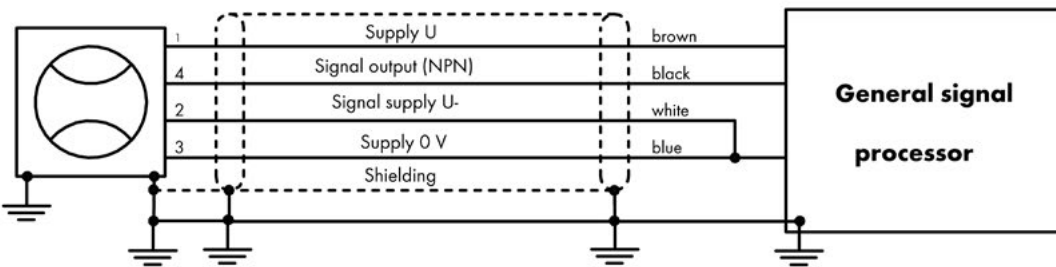
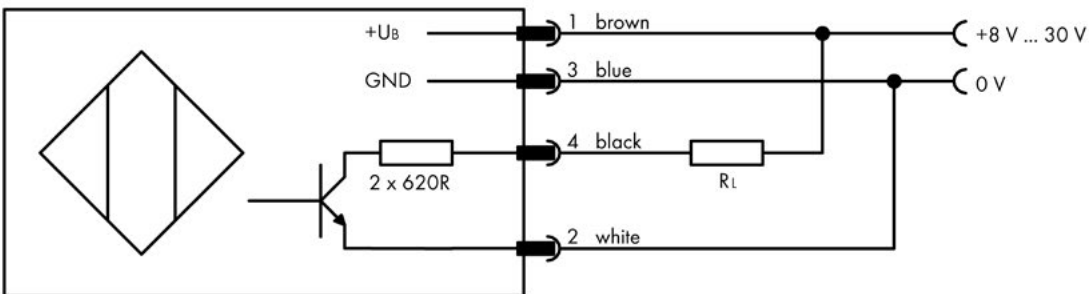

Signal output NPN-switching

27. TYPE CODE SIGNAL PICK-UPS

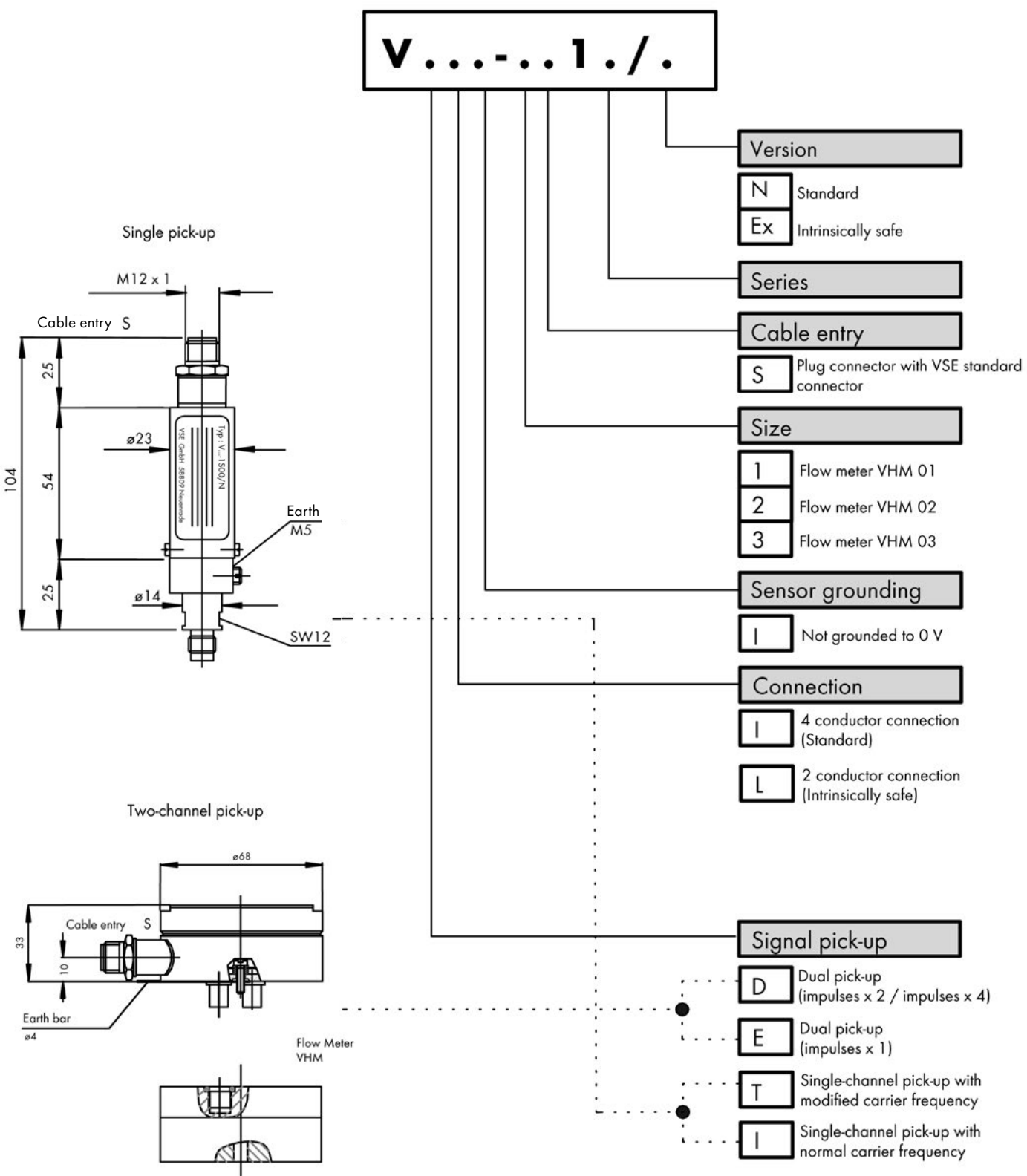

* With the VDB series... (fiber-optic output), the signal can only be doubled (pulse x 2)

28. TECHNICAL DATA FOR VHM-TITAN

Size	Measurement range l/min	Measured Volume V_m ml	Frequency Hz	K-Factor imp./Liter
VHM 01-1_T1	0.01 ... 1	approx. 0.04	approx. 5 ... 417	approx. 24,000
VHM 02-2_T1	0.05 ... 2	approx. 0.11	approx. 7.6 ... 303	approx. 8,800

The exact data can be found in the calibration report.

Measurement accuracy	± 0.5% of the measured value (at viscosities > 10 mm ² /s) ± 1% of the measured value (at viscosities 1 – 10 mm ² /s)
Repeating accuracy	± 0.5% under the same operating conditions
Materials	Gear housing: Titanium Gears: Stainless steel 1.4462 Gear bearings: tungsten carbide Preamplifier housing: Aluminum (Al Mg Si 1) EN AW – 6082
Gear bearings	Sleeve bushing
Seals	PTFE with FPM core or PTFE
Max. operating pressure	10 bar / 145 psi
Media temperature	-20 ... + 85°C (-4°F ... 185°F) (*)
Ambient temperature	-20 ... + 60°C (-4°F ... 140°F) (*)
Viscosity range	1 ... 20,000 mm ² /s
Installation position	Any
Direction of flow	See direction of the arrow on the flow meter
Installation	Block mounting
Protection class	Block mounting

(*) Please also note the temperature range of the preamplifier in this case.

29. DIMENSIONS FOR VHM-TITAN

Flow meter with preamplifier

VHM 01-22TS1/1. + V.L. - 01S00/.

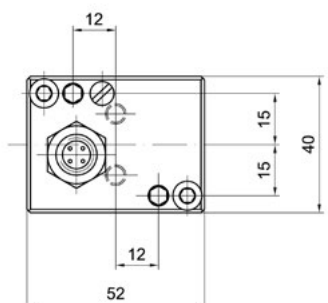
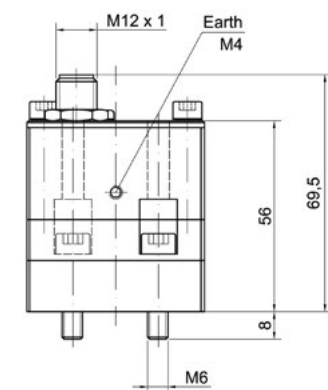

Preamplifier

VR11 – 01S00 / N Standard

VR11 – 01S00 / Ex intrinsically safe

VW11 – 01S00 / N Standard

VW11 – 01S00 / Ex intrinsically safe

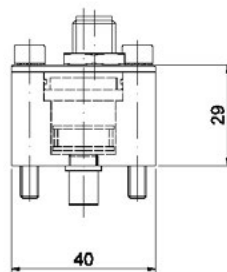

Flow meter

VHM – 01-22TS1/1 N Standard

S Special shaft

D D-Shaft

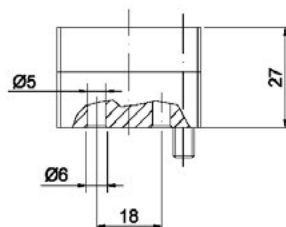

Flow meter with preamplifier
VHM 02-12TS13/1. + V.L. - 02S00/.

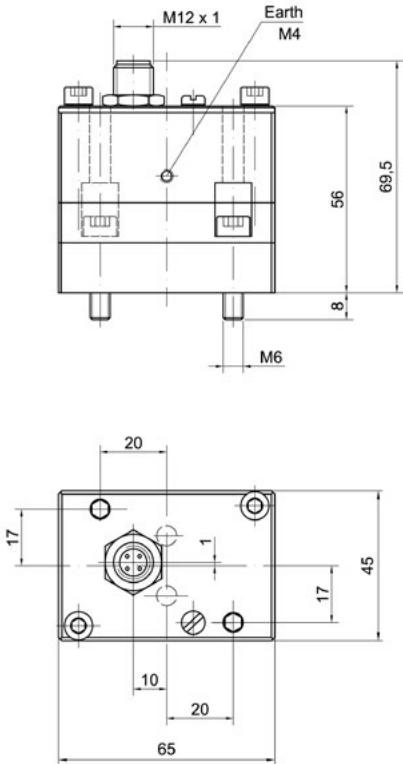

Preamplifier

- VRII - 02S00 / N** Standard
- VRLI - 02S00 / Ex** intrinsically safe
- VWII - 02S00 / N** Standard
- VWLI - 02S00 / Ex** intrinsically safe

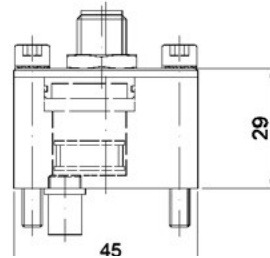

Flow meter

- VHM - 02-12TS13/1 N** Standard
- S** Special shaft
- D** D-Shaft

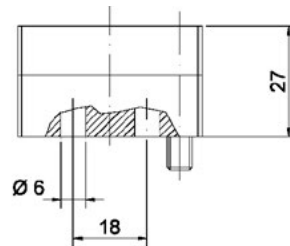

30. TYPE CODE FOR VHM-TITAN

Flow meter VHM-Titan

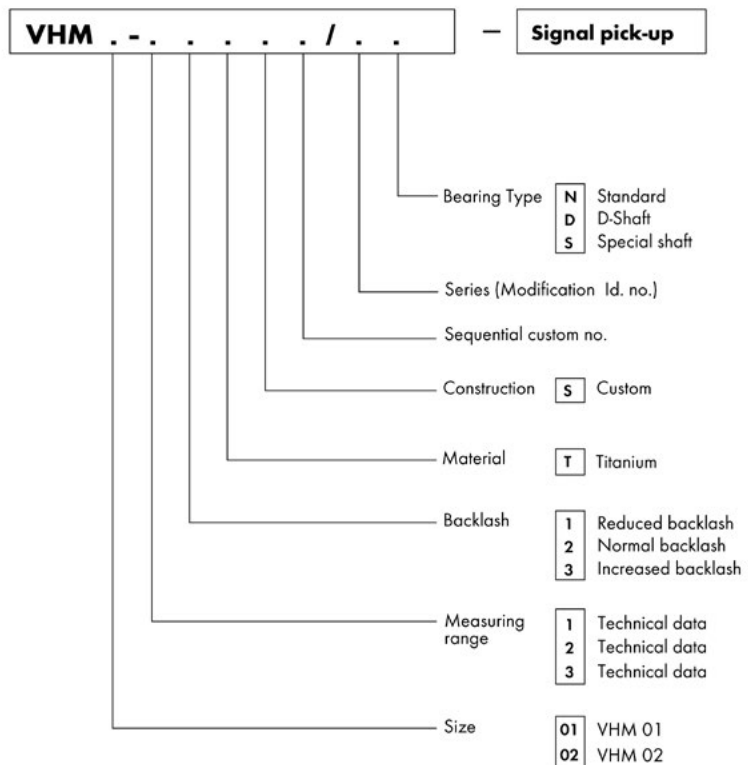

31. TECHNICAL DATA FOR SINGLE PICK-UPS VRI*-S/N; VWI*-S**/N FOR VHM TITAN**

Supply voltage	$U_b = 8 \dots 30 \text{ V DC} \pm 10\%$
Current consumption (idle)	$I_b = \text{approx. } 4 \text{ mA}$ (idle motion, $U_b = 30 \text{ V DC}$)
Signal output circuit	Transistor with series resistor $R=2 \times 620 \Omega$ PNP and NPN selectable
PNP signal output	High Signal: $U_s = U_b - 1 \text{ V}$; $I_s = 10 \text{ mA max.}$
NPN signal output	Low Signal: $U_s = U_b - 0 \text{ V}$; $I_s = 10 \text{ mA max.}$
Signal switching frequency	3 Hz – approx. 1.000 Hz (*)
Electrical connection	4-pole VSE standard plug M12
Medium temperature	-20°C ... +85°C (-4°F ... 185°F)
Ambient temperature	-20°C ... +60°C (-4°F ... 140°F)
Material	Al Mg 4.5 Mn 0.7
Weight	125 g

(*) depends on flow meter size

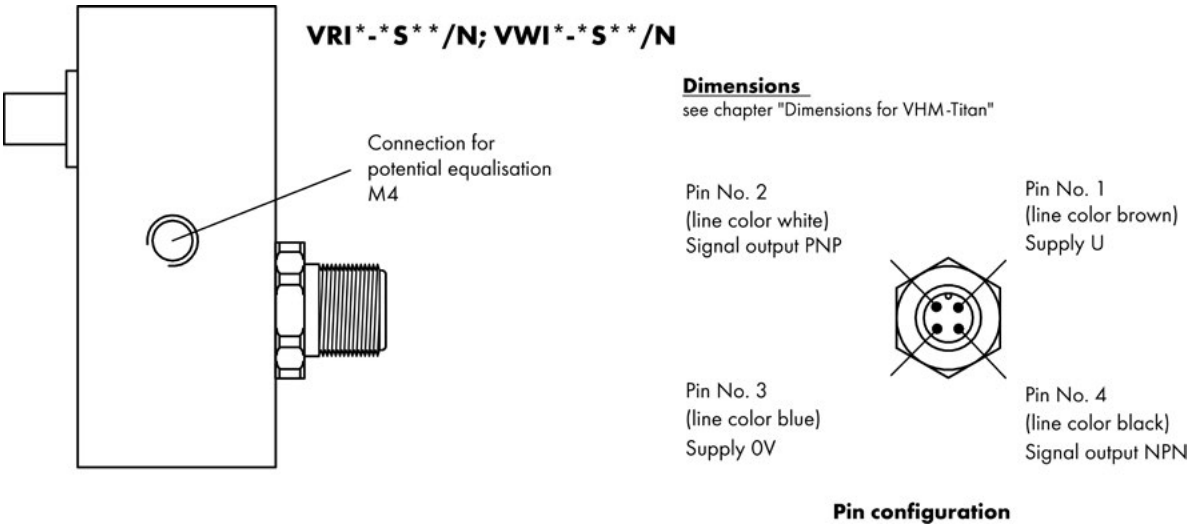

32. ELECTRONIC CONNECTION DATA FOR SINGLE PICK-UPS VRI*-S/N; VWI*-S**/N FOR VHM TITAN**

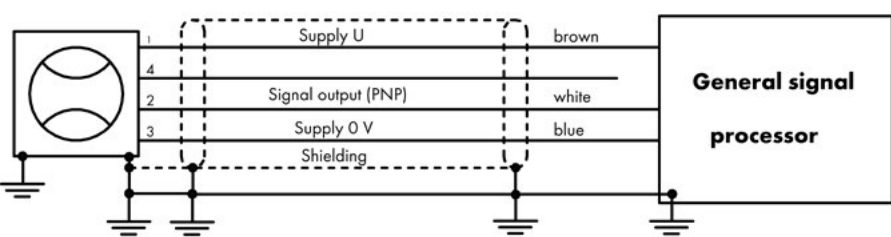
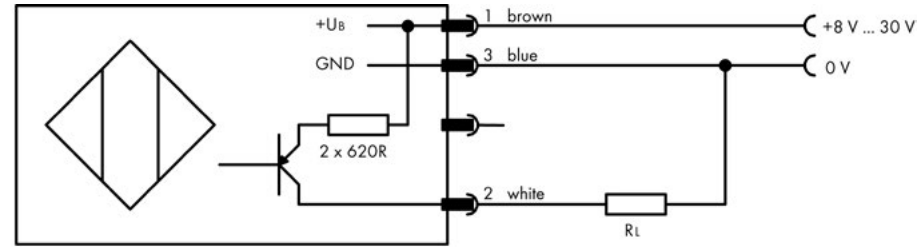

Output signal PNP-switching

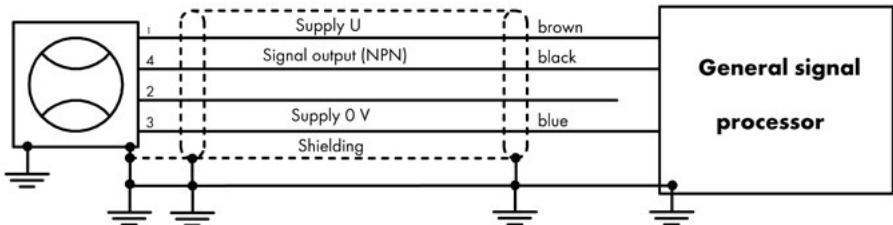
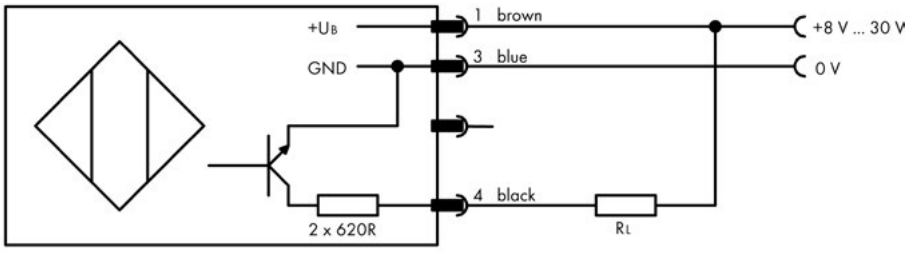

Signal output NPN-switching

33. TYPE CODE SIGNAL PICK-UPS FOR VHM-TITAN

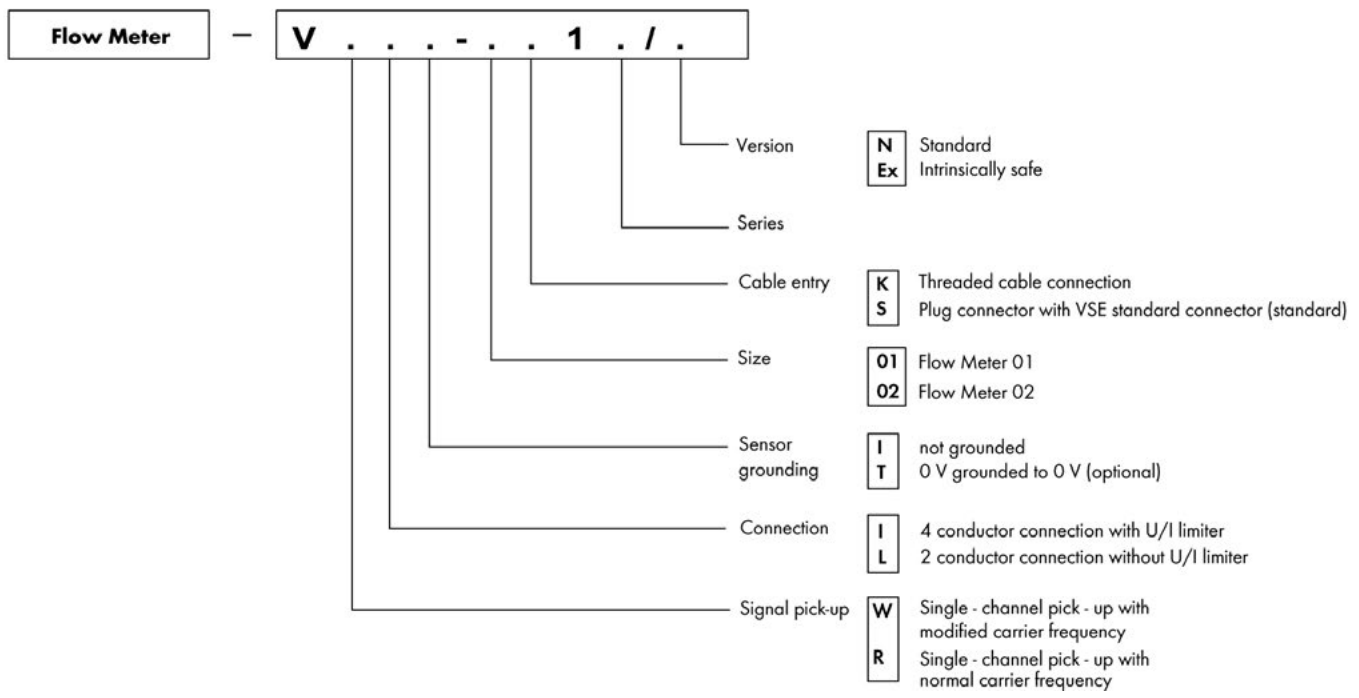

Declaration of non-objection (Decontamination declaration for return deliveries)

Last Revision: 03/2025

In order to ensure occupational health and safety and to protect our employees from harmful effects when handling hazardous substances, this decontamination declaration must be fully completed and enclosed with all VSE flow meters which are returned.

The declaration is binding and may only be completed and signed by authorised personnel. It must be visibly attached on the outside of the return packaging and sent in advance by email, including all safety data sheets. VSE and its sales partners will only conduct an inspection and failure analysis of the returned VSE flow meters if a fully completed and signed declaration is provided. Otherwise, we explicitly reserve the right to reject the shipment.











It is mandatory to obtain written approval before returning any VSE flow meters.

Approval was granted on by (contact person)

Type	<input type="text"/>		
Serial number	<input type="text"/>	Quantity	<input type="text"/>
Reason for return	<input type="text"/>		

1. The VSE flow meter was last used with the following operating medium:
(Safety data sheet must be enclosed.)

Application-related contamination and effects:

 irritant	<input type="radio"/>	 harmful to health	<input type="radio"/>	 radioactive substances ¹	<input type="radio"/>
 toxic	<input type="radio"/>	 corrosive	<input type="radio"/>	 biologically hazardous substances ¹	<input type="radio"/>
 hazardous to the environment	<input type="radio"/>	 flammable	<input type="radio"/>		
 oxidising	<input type="radio"/>	 explosive	<input type="radio"/>		

¹ The return of VSE flow meters that have been contaminated by radioactive or biologically hazardous substances is expressly excluded.

2. The VSE flow meter has been carefully emptied, decontaminated and thoroughly cleaned both inside and outside, removing all residues.
The following cleaning agents were used:
(Safety data sheets must be enclosed).

Declaration of non-objection (Decontamination declaration for return deliveries)

3. No special safety measures or treatments are necessary.
- Special safety measures or treatments concerning employee protection, environmental protection, and/or disposal are required due to residual contamination, residual liquids, residual substances, solids, and/or used cleaning agents. (Safety data sheets must be enclosed.)

If yes, which:

4. Are there any other safety aspects to consider?

If yes, which:

We confirm that the information provided in this declaration is true and complete and that the shipment is carried out in accordance with legal regulations. We are aware that we are liable to VSE and its sales partners for any damages caused by incomplete and incorrect information. We commit to indemnify VSE and its sales partners against any claims for damages by third parties arising from incomplete or incorrect information, irrespective of the legal basis on which such claims may arise.

Company

Street/No.

Postal code/City

Phone

Email

Contact person

(In capitals)

Date

Signature

(Company stamp)

Enclosures

VSE.flow®

VSE Volumentchnik GmbH
Hönnestraße 49
58809 Neuenrade / Germany
Phone +49 (0) 23 94 / 6 16-30
info@vse-flow.com
vse-flow.com



A company of
e.holding
FLUID TECHNOLOGY GROUP